

REV.	DATE	ECO	DESCRIPTION	BY	CK	APP
C	9-4-13	N/A	REDRAWN: REVISED DIMENSIONS	LDB	N/A	N/A

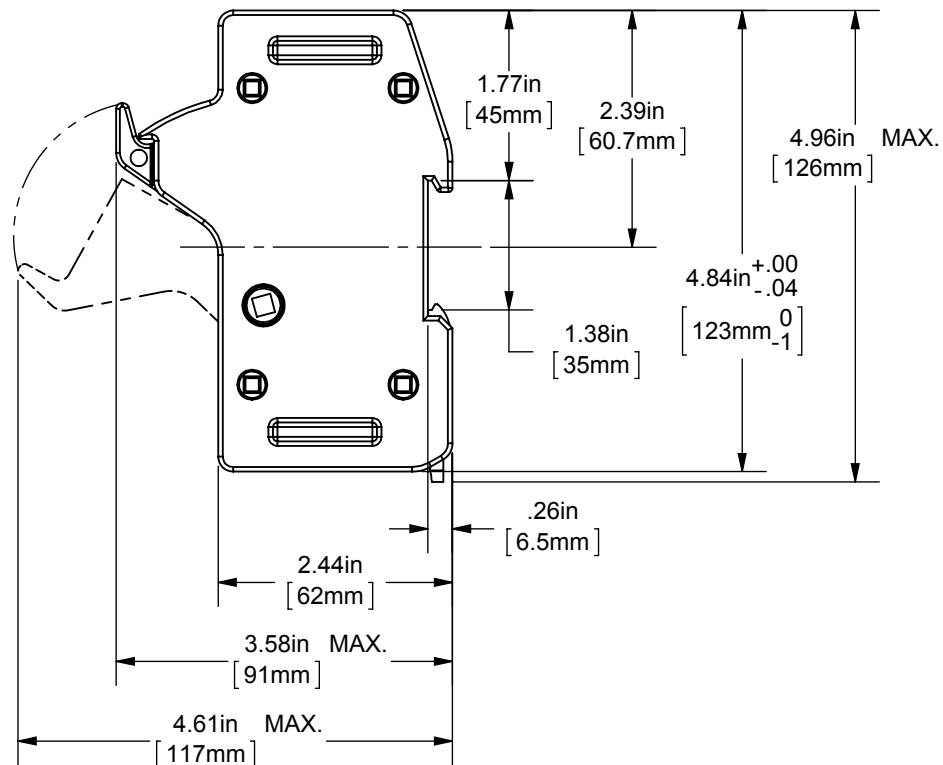

P/N	CONN TYPE	RMS SYM RATING	TORQUE (IN-LBS)	WIRE			UL		CSA
				WIRE RANGE	°C	TYPE	FILE NO.	GUIDE NO.	REPORT NO.
US6J3 US6J3I	PRESSURE PLATE	200K	45	#2-#14	75	CU	E52283	IZLT	LR32169

DIMENSIONS IN [] ARE MILLIMETERS

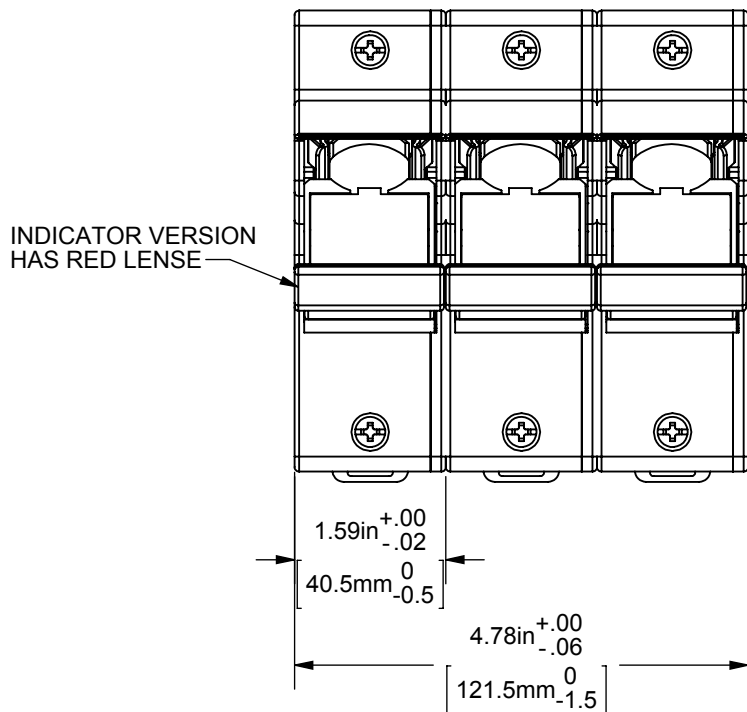

MERSEN USA NEWBURYPORT-MA, LLC
374 MERRIMAC STREET
NEWBURYPORT, MA 01950

US6J3(I)

FUSE HOLDER, 3 POLE, CLASS J

600V 60A

OUTLINE DIMENSIONS
NOT TO BE USED FOR PRODUCTION

700434

PRODUCT MANAGER
SIGN:
DATE:

DESIGN ENGINEER
SIGN:
DATE: